

COTEL UK RENTAL

WIRELESS COMMUNICATIONS 4 BUSINESS

Local • Regional • National • Global

CUSTOMER CARE: 08000 960 970

WWW.COTELTELECOM.CO.UK

Introducing the Cotel 'Matrix' Radio Gateway

Cotel Matrix - Link LMR Radios, LTE Radios, IP Radios, IP Phone Systems and More



COTEL UK RENTAL

WIRELESS COMMUNICATIONS 4 BUSINESS

Local • Regional • National • Global

CUSTOMER CARE: 08000 960 970

WWW.COTELTELECOM.CO.UK

Ensures Cooperative Information Sharing Across Systems and Devices

The Cotel Matrix is a versatile RoIP (Radio over IP network) gateway unit, which seamlessly interconnects LMR radios, LTE radios, IP communication terminals, IP phone systems and external devices. In addition to the IP Network (LAN/WAN), the built-in LTE module* provides virtually nationwide communication coverage.

* Network coverage provided by a custom SIM card.



Communication Links

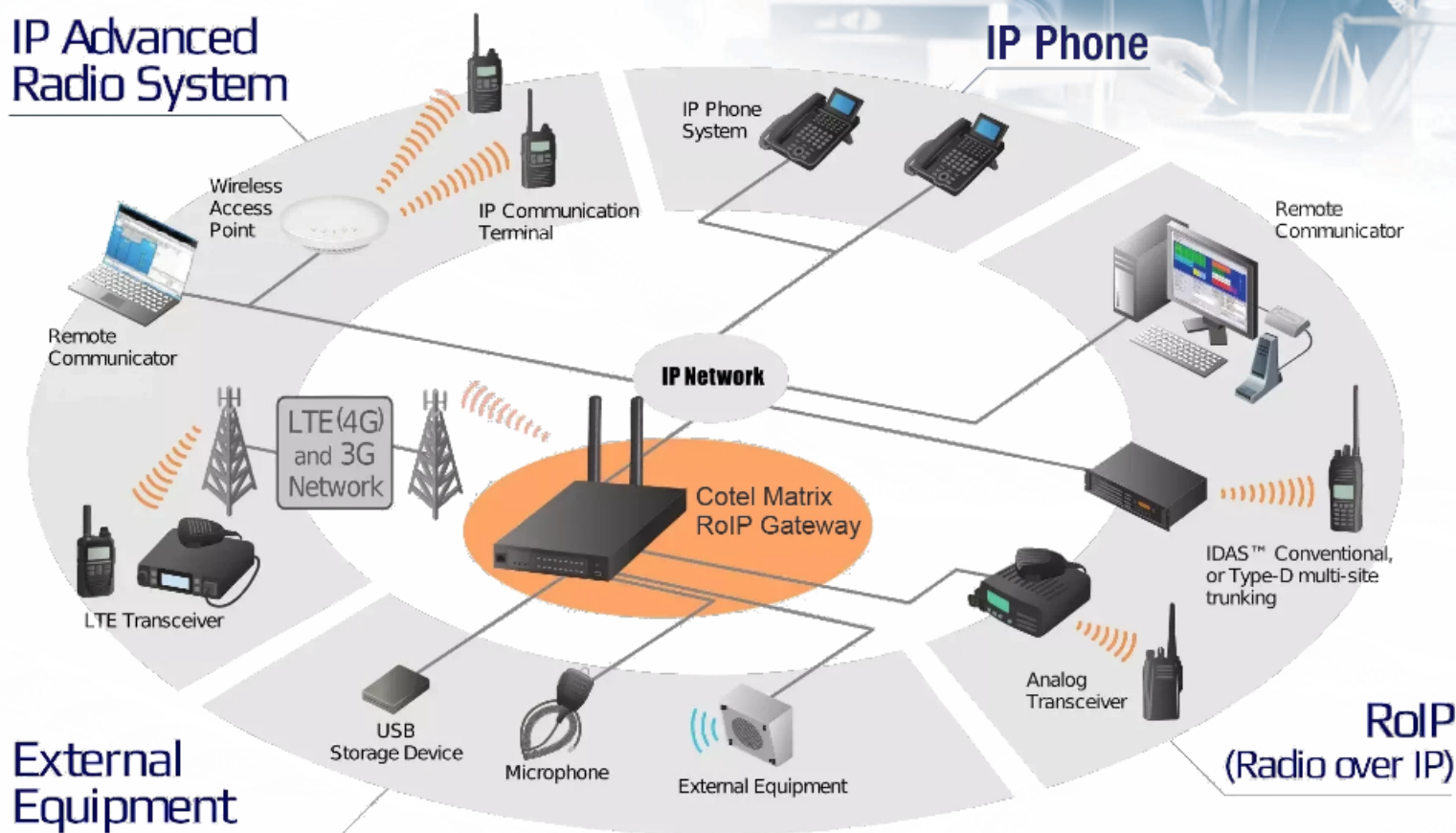

Features

All in One Package

The Cotel Matrix includes built-in RoIP, SIP gateway, IP router, IP PBX and IP communication terminal controller functions, in one box. In comparison with a similar system combining several devices, installation and administration of the integrated gateway can be simpler, with less conflict of settings.

Call Recording to a USB Drive

Incoming/Outgoing calls can be recorded to an external USB device connected to the Cotel Matrix. Up to four recording settings are programmable. The recording call type is selectable from All, Group, and Individual calls. In addition, the Monitor function transfers the received audio data to an intended device.

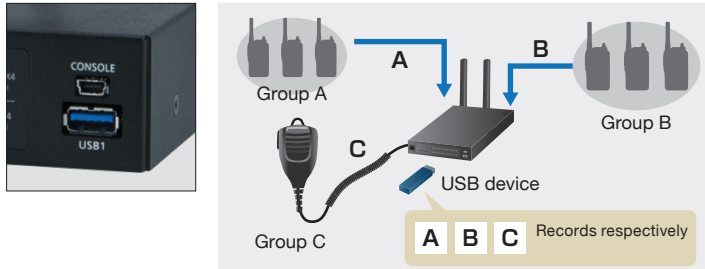

Microphone Connection for Base Operation

Connect HM-241, optional speaker-microphone to the microphone connector on the front panel to enable simple base operation. Echo canceller and noise canceller functions are built-in for full-duplex communication with an IP Radio system.

Position and Status Information

GPS position and status information from the Cotel "Connect" LTE transceivers can be received and transferred to a PC to track the location of the radio users or a user in a vehicle.

* GPS mapping software is required for GPS data.

Remote Communicator Software

The optional remote communicator software creates an IP-based virtual radio on a PC, and can communicate with land mobile radios, LTE radios, and IP communication terminals through the Cotel Matrix.



Serial Pass-through Function

The Serial Pass-through function enables you to connect a serial device to the gateway to extend the communication range between the connected device and a controller PC.

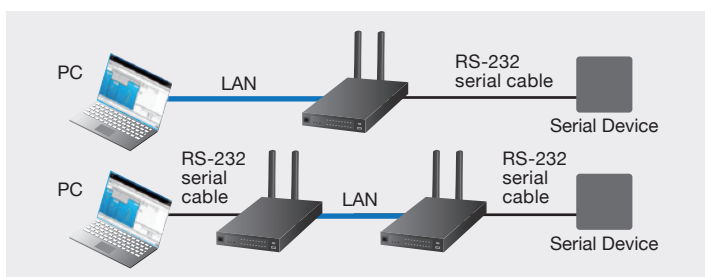

SIP Server and IP-PBX Functions

The built-in simple SIP server enables you to assign IP phone numbers with extension groups. The gateway can be connected to external SIP server as a client. The following IP-PBX settings are programmable.

- Voice Phonebook
- DID (Direct Inward Dialing)
- Used with Panasonic KX-UT and KX-HDV series IP phones
- Call log
- Extension presence
- Phone number routing
- Outside line regulations
- Caller prioritization
- External call limiting
- SIP conferencing

Router Functions with VPN Tunnel

The Cotel Matrix supports LAN, DHCP client, Static IP or PPPoE connections. The VPN function creates a secure IP tunnel connection over the Internet.

Half-width 1U Form Design

The gateway occupies only half the width of a 19-inch rack. It can be functionally installed with repeaters, switching hubs and other equipment. LTE (4G)/3G antenna bases with 1.5 m (4.9 ft) of cable are supplied in case antennas need to be relocated for better reception.



Online Firmware Update

The Cotel Matrix supports automatic and online firmware update functions, for remote maintenance. Settings can be saved to a backup file, and easily restored.

Management Features

- SYSLOG and SNMP
- Telnet and SSH
- Ping Test and Traceroute Test
- Abnormal condition monitoring, such as LAN port link-down and SIP server registration error
- Administrator password
- SNMP server
- Security slot

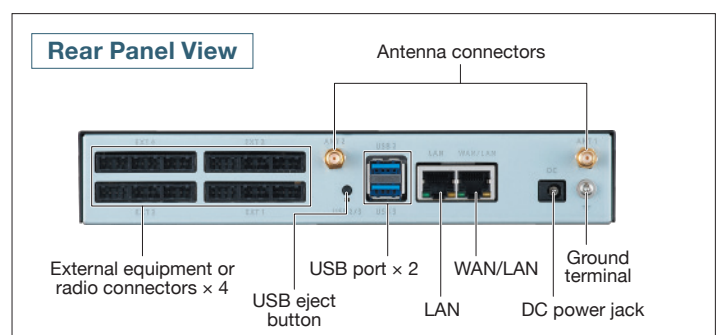

Built-in Controller for the IP Communication Terminal (Wireless LAN)

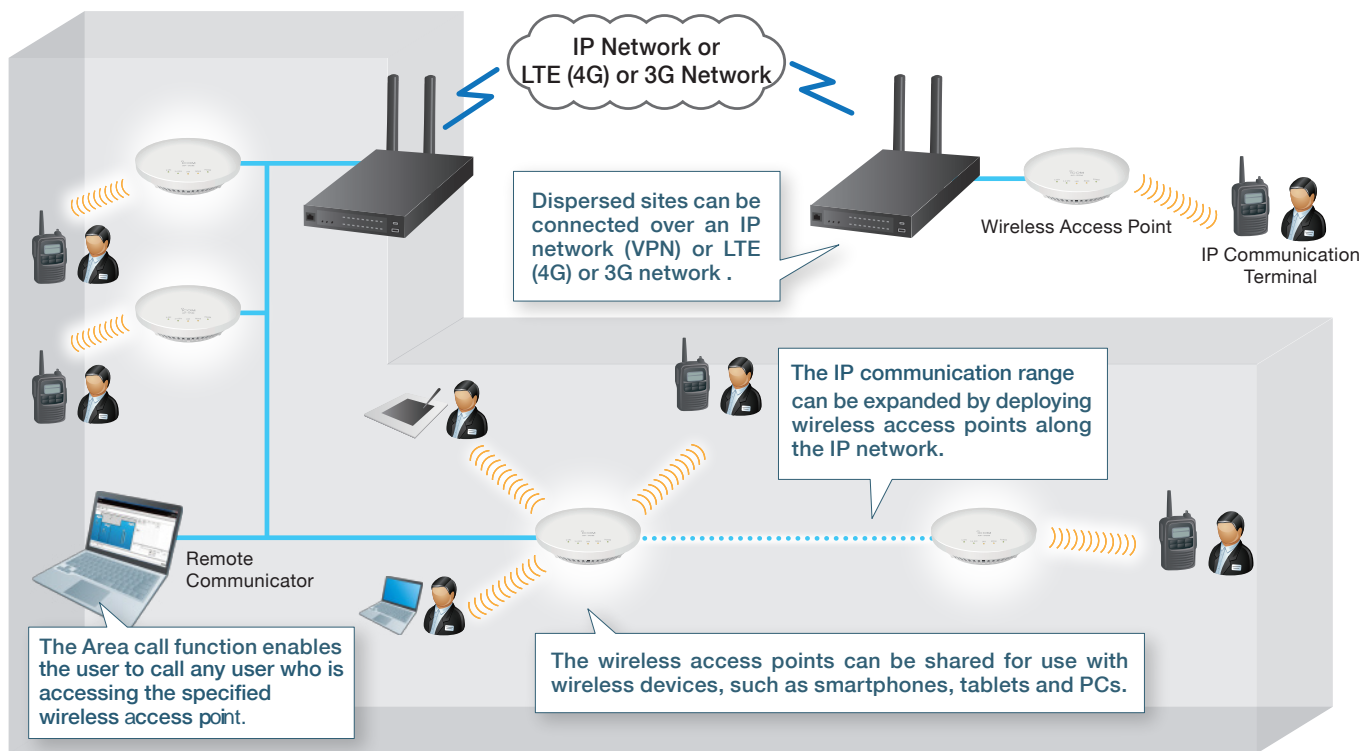

The Cotel Matrix has a built-in IP communication terminal controller function that is capable of controlling up to 50 IP Communication Terminals and Remote Communicators. The IP Radio can send and receive voice and preprogrammed text messages to the other messages to the other units through the wireless LAN access points. The IP communication terminals are suitable for in-building communication, which will communicate anywhere your network has Wireless LAN access.

Wireless Communication System

By deploying access points along the existing IP network, the IP advanced radio system can communicate from anywhere in the facility. The IP Radio can access the nearest access point, and can roam between access points. No license fee is required, and there are no call charges.

Hands-free, Full-duplex Communication

With an optional earphone-microphone or headset, the IP Radio user can simultaneously talk and receive like a phone call. Hands-free operation allows your staff to carry out other tasks at the same time.

Individual, Group, All or Area Communication

Staff spread across multiple rooms can communicate seamlessly. The IP communication terminal can receive Data Messages with a vibration alert from a PC installed with a Remote Communicator.

Easy System to Set Up and Use

The gateway programs almost all terminal configurations over the air. Individual PC programming through a cable connection is not required. (Except initial setup).



IP Communication Terminal

- License-free wireless LAN communication terminal using IEEE 802.11 a/b/g/n standards (2.4 GHz and 5 GHz)
- WPA-PSK or WPA2-PSK encryption
- IPX7 waterproof (1 m depth of water for 30 minutes)
- MIL-STD 810 G rugged construction
- Compact 58 x 95 x 26.4 mm; 2.3 x 3.7 x 1 in body and a light 205 g; 7.2 oz (approximate) weight
- Vibration alert function notifies incoming calls
- Emergency call with higher priority

Remote Communicator

- The Communicator can communicate with IP communication terminals from a PC
- It can obtain location information of each IP Radio based on the access point being used
- It can be installed on a Windows® based tablet PC, as well as a laptop PC



Wireless LAN Access Point

- IEEE 802.11ac (Wave 2) standard, high-speed communication
- Beam forming function, MU-MIMO function
- Optional RS-AP3, access point management software



Bridge Connection between Radio Systems

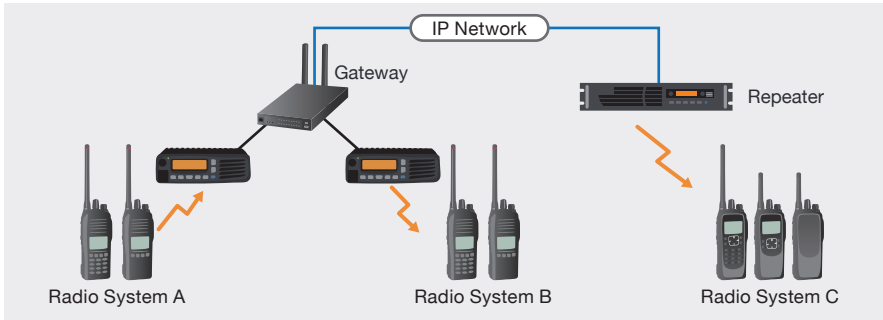

The gateway interconnects with 2 or more radio systems, even when the systems are using different bands and different categories. All received audio is bridged to opposing radio system, so a radio user can talk to all connected radio users. The built-in digital voice converter converts analog audio to IDAS™ compatible digital audio.

* Cross band/cross category operation may be prohibited in some countries. Please check the legal requirements in your country before installation.

LTE Transceiver Gateway

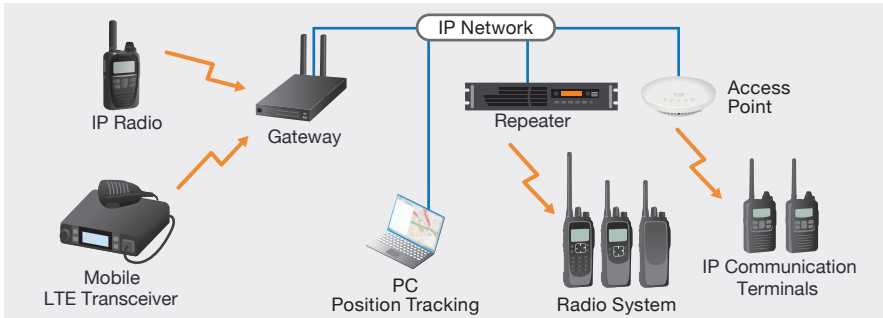

By installing a custom SIM card to the built-in LTE module, the Cotel Matrix can interconnect multiple LTE transceivers with conventional radio systems and connect IP communication terminals. GPS position information from the LTE transceivers can be received and transferred to a PC.

IP Phone Interconnect

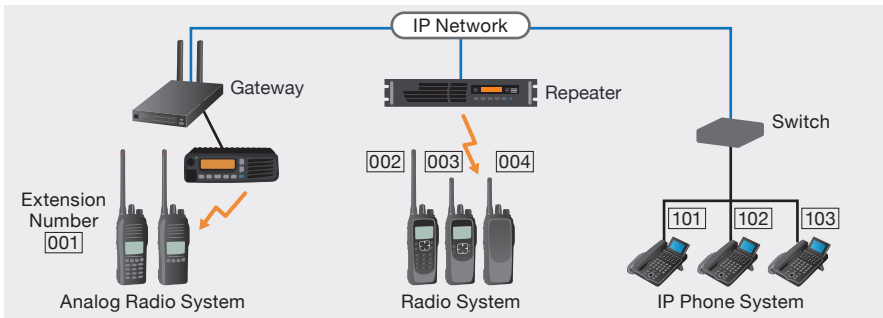

The built-in Simplified SIP server can assign extension numbers to IDAS™ radio terminals, IP advanced radio terminals, and groups of analog radio users as well as IP phones. A radio user can initiate phone calls. Phone users can make individual or group calls to connected radio users.

Multi-site Connection between Gateways

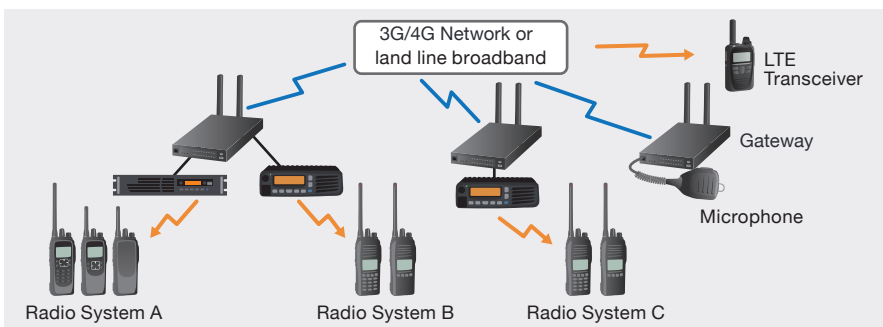

Two or more gateways can be connected through LAN or LTE (4G) and 3G networks. The communication area can be flexibly expanded, and dispersed radio sites can be connected, regardless of distance or radio system used.

External Equipment Connection

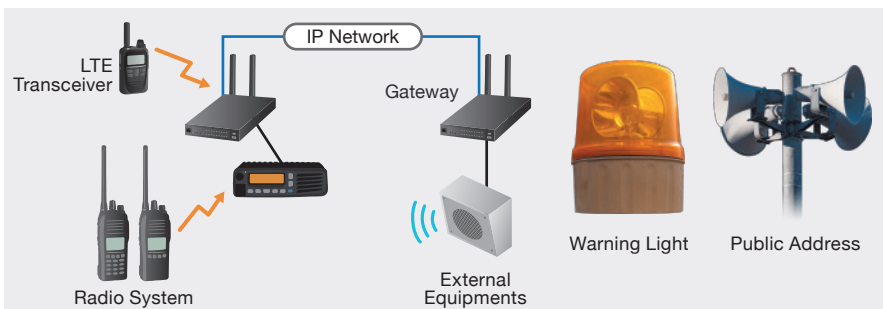

Public address system, siren, warning light and other external devices can be connected to the gateway. When detecting an emergency signal, users can start emergency notification from either a digital transceiver, IP transceiver or public address system.